













AMF THERMATEX® SONIC SKY

- AMF THERMATEX® Sonic Sky is a flexible ceiling raft system, and is available in a wide range of colours and shapes. The unique design offers architects and designers the opportunity to create exciting ceiling clouds in any interior space. The rafts consist of a self-supporting frame fixed to the ceiling with an adjustable suspension system and are installed with AMF THERMATEX® acoustic ceiling tiles
- AMF THERMATEX® Alpha and Alpha HD laminated ceilings are available in a variety of colours, and are ideal for offices, classrooms and learning applications
- Suspension cables are discreet and virtually invisible



AMF THERMATEX® SONIC SKY

Thickness (mm)		40																					
Dimensions (mm)		1200 x 1200 2400 x 2400 2440 x 1240 3600 x 1800 Additional dimensions on request																					
System		Wire Hanger																					
Weight		3.0 - 6.0 kg/m ²																					
Colour & design		White Colour																					
Sound absorption		<p>EN ISO 354</p> <table border="1"> <thead> <tr> <th>Frequency f (Hz)</th> <th>125</th> <th>250</th> <th>500</th> <th>1000</th> <th>2000</th> <th>4000</th> </tr> </thead> <tbody> <tr> <td>Equivalent Absorption Area Aobj*</td> <td></td> <td></td> <td></td> <td></td> <td></td> <td></td> </tr> <tr> <td>Sonic Sky Alpha 1200x1200mm Suspension height 300mm</td> <td>0.35</td> <td>0.85</td> <td>1.15</td> <td>1.80</td> <td>1.95</td> <td>1.95</td> </tr> </tbody> </table> <p>*Values shown are the average of the 3 one third octave band values</p>	Frequency f (Hz)	125	250	500	1000	2000	4000	Equivalent Absorption Area Aobj*							Sonic Sky Alpha 1200x1200mm Suspension height 300mm	0.35	0.85	1.15	1.80	1.95	1.95
Frequency f (Hz)	125	250	500	1000	2000	4000																	
Equivalent Absorption Area Aobj*																							
Sonic Sky Alpha 1200x1200mm Suspension height 300mm	0.35	0.85	1.15	1.80	1.95	1.95																	
Light reflectance		Up to 88%																					
Humidity resistance		95%																					
Cleanability	 																						
Sustainability																							

Frame detail

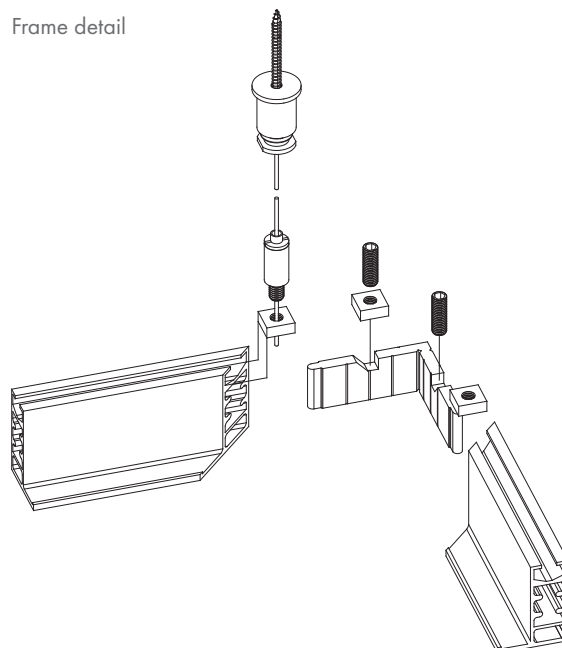

Flexible design and adjustable to various heights using steel cables.

Products may vary from country to country. Please contact your local sales representative.
For further information and legal notice, please visit our website.